

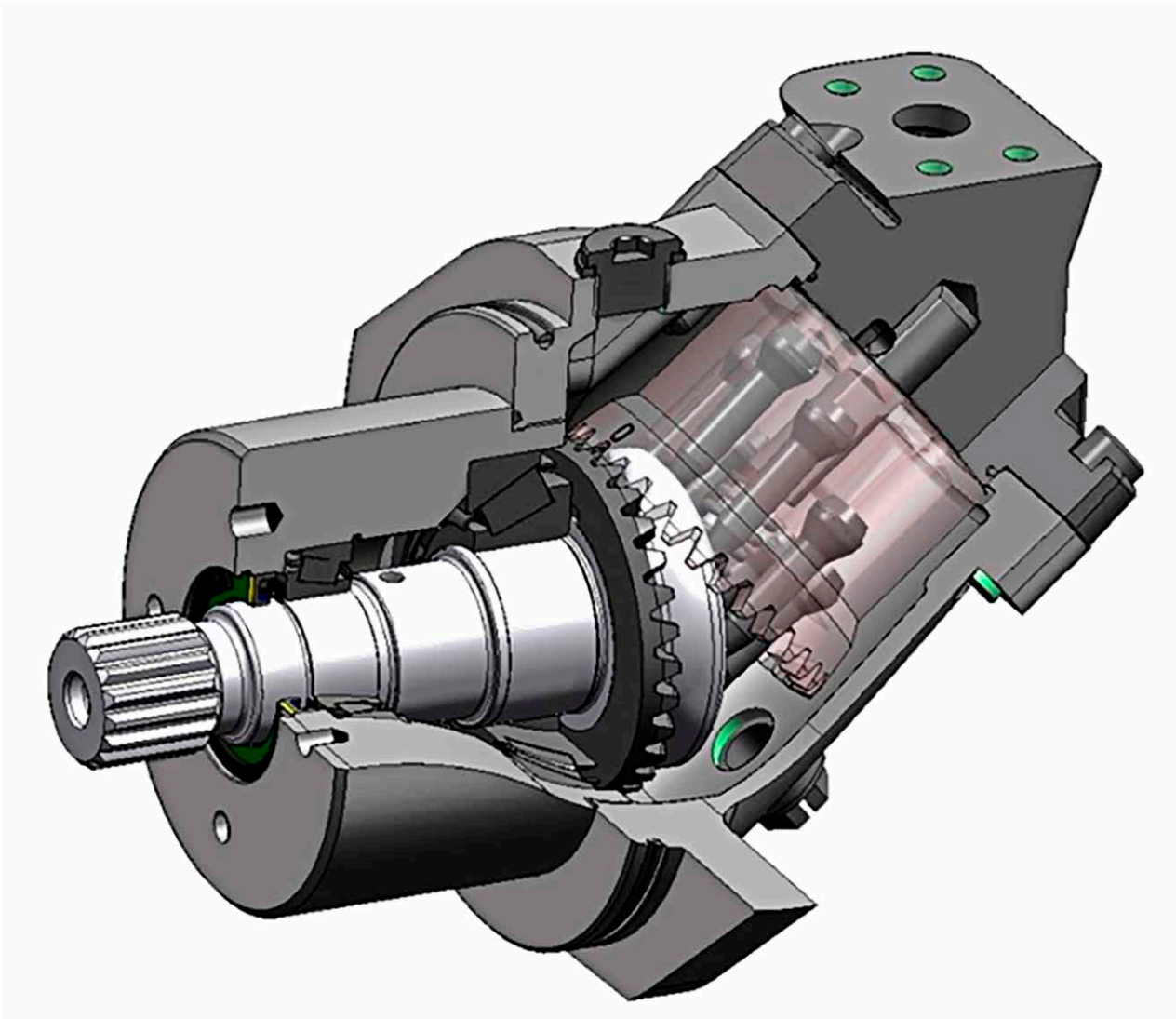

EFFICIENCY CURVES - SCM

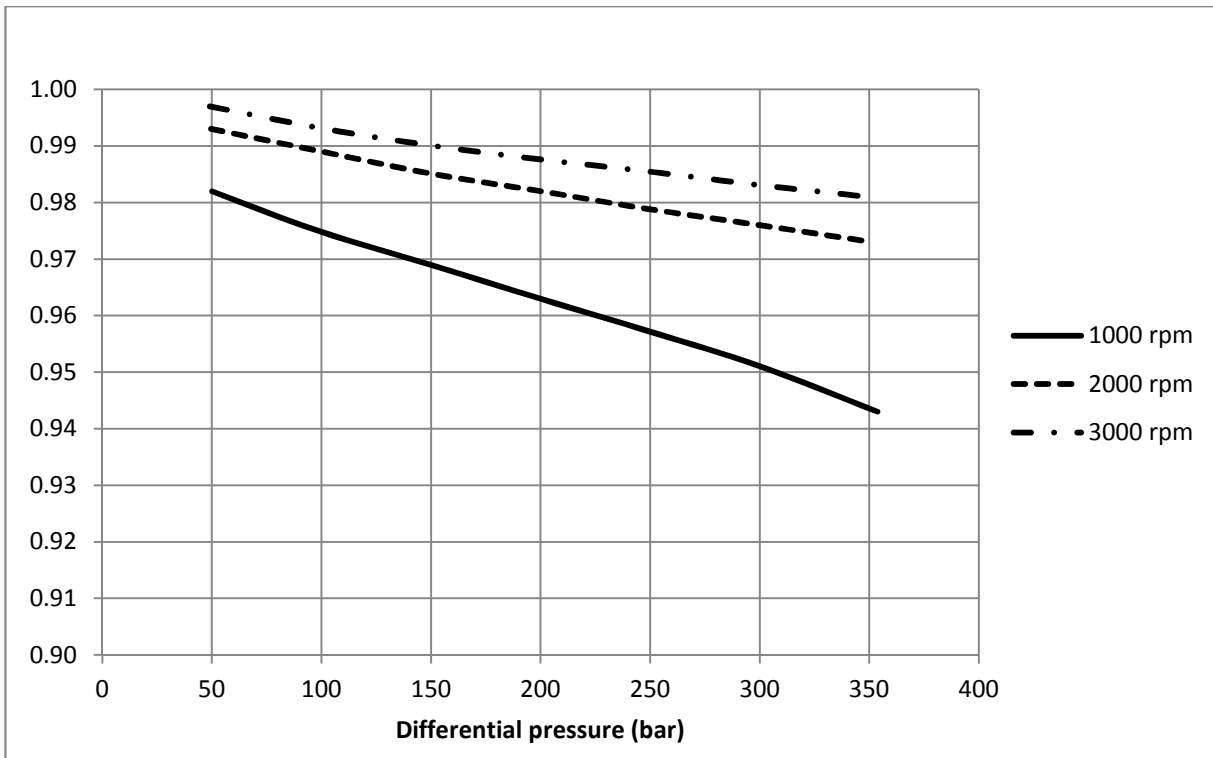

SCM 012 Volumetric efficiency



SCM 012 Hydraulic-mechanical efficiency

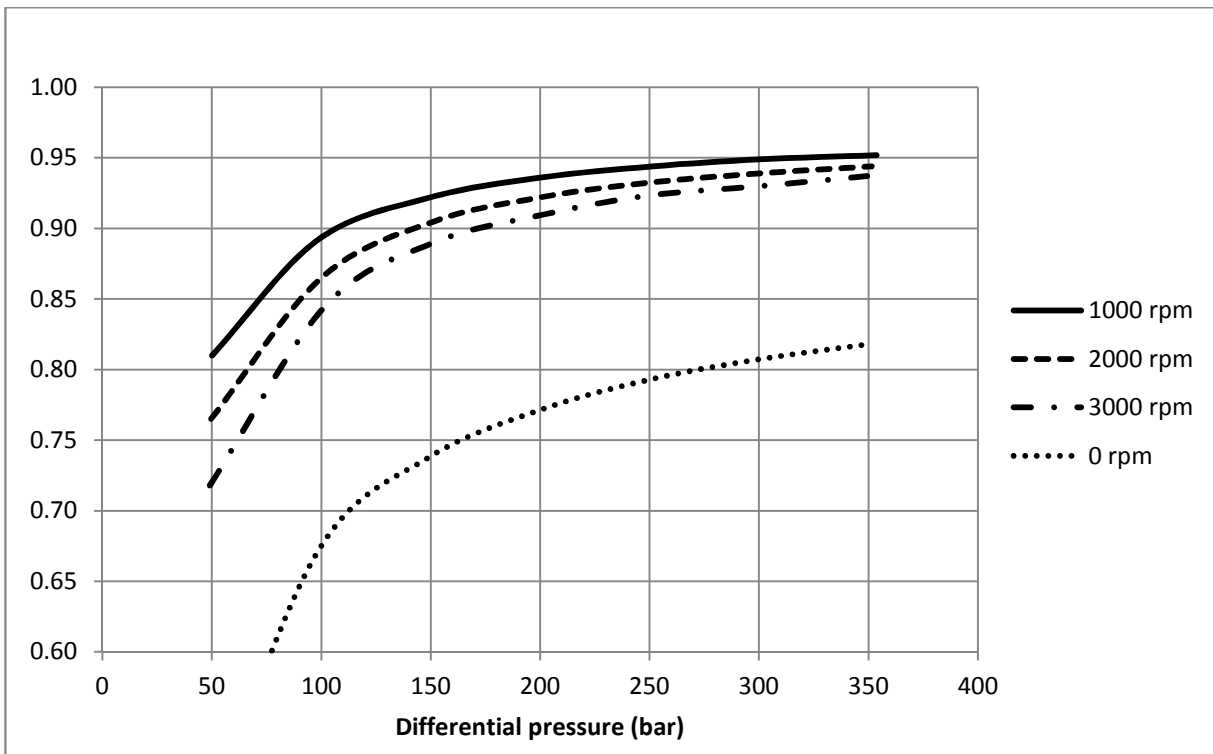

SCM 017 Volumetric efficiency

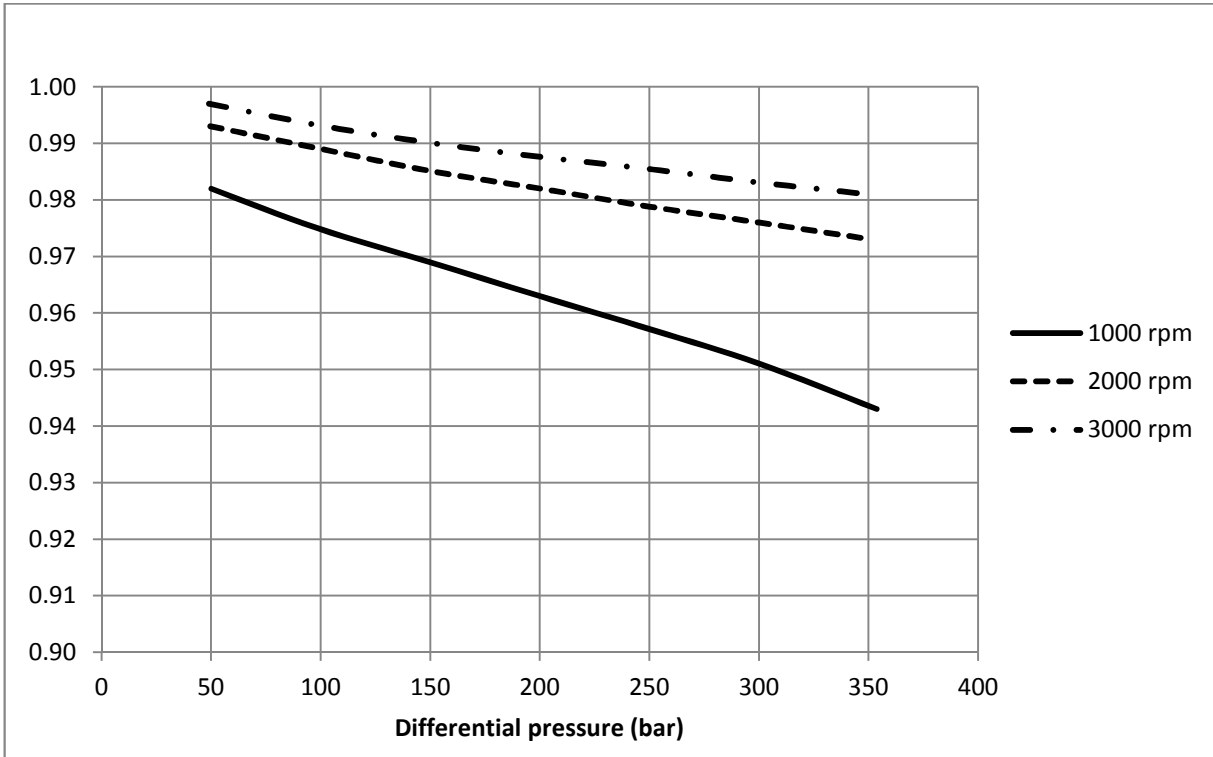

SCM 017 Hydraulic-mechanical efficiency

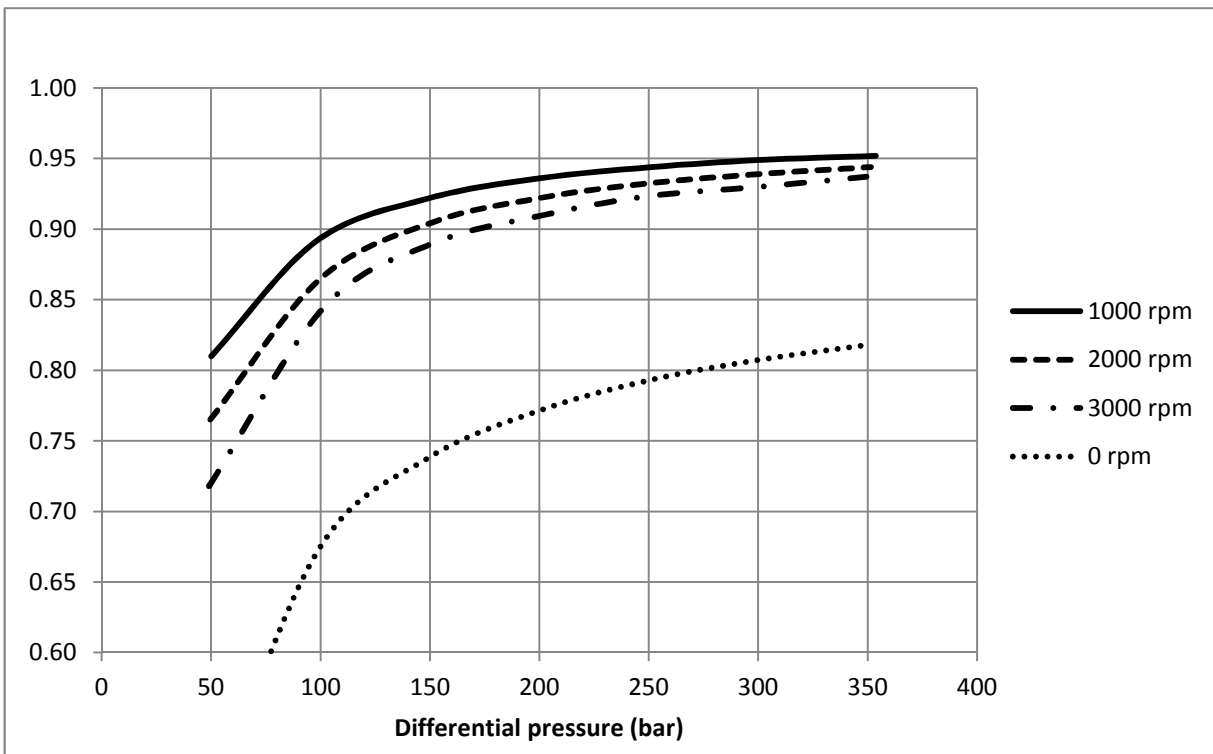

SCM 025 Volumetric efficiency

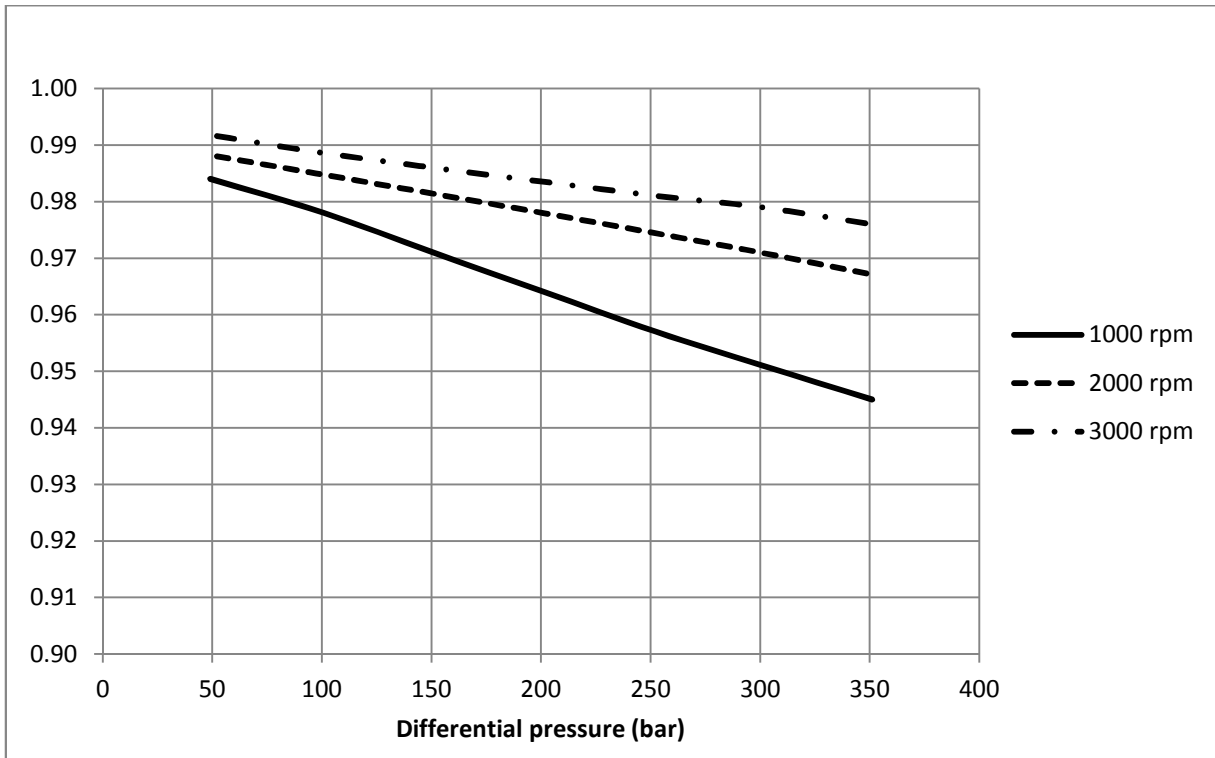

SCM 025 Hydraulic-mechanical efficiency

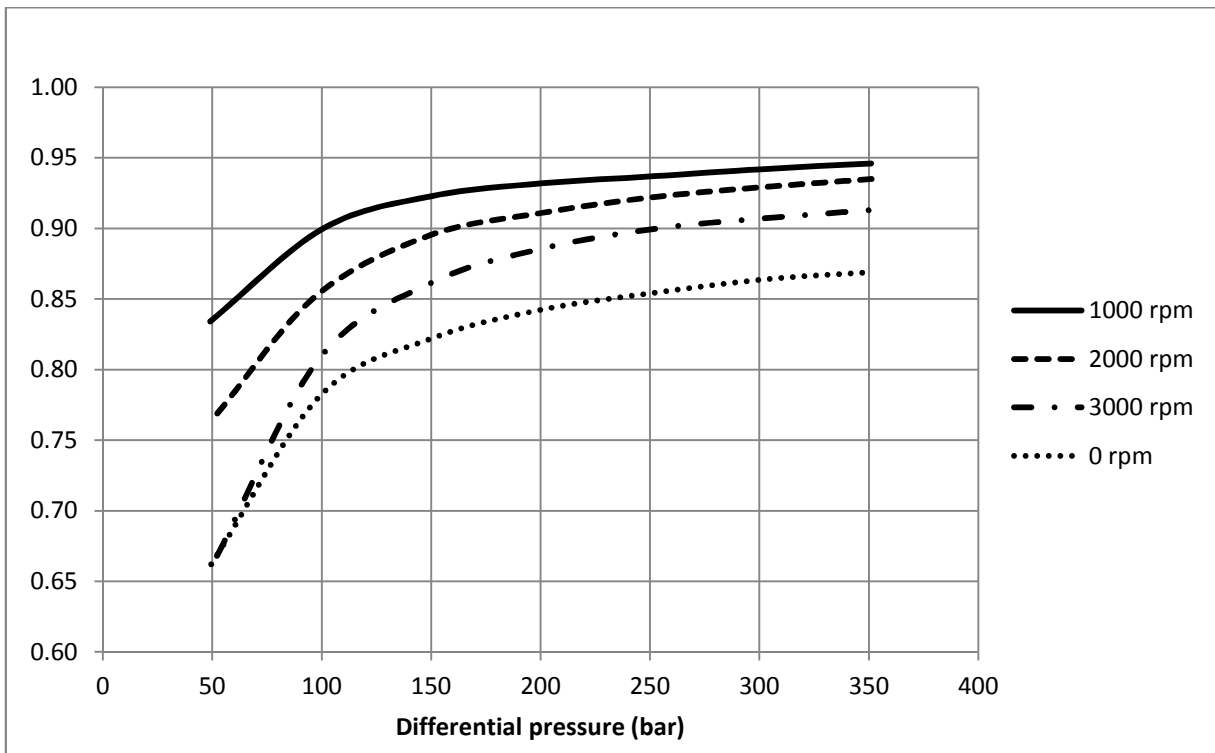

SCM 034 Volumetric efficiency

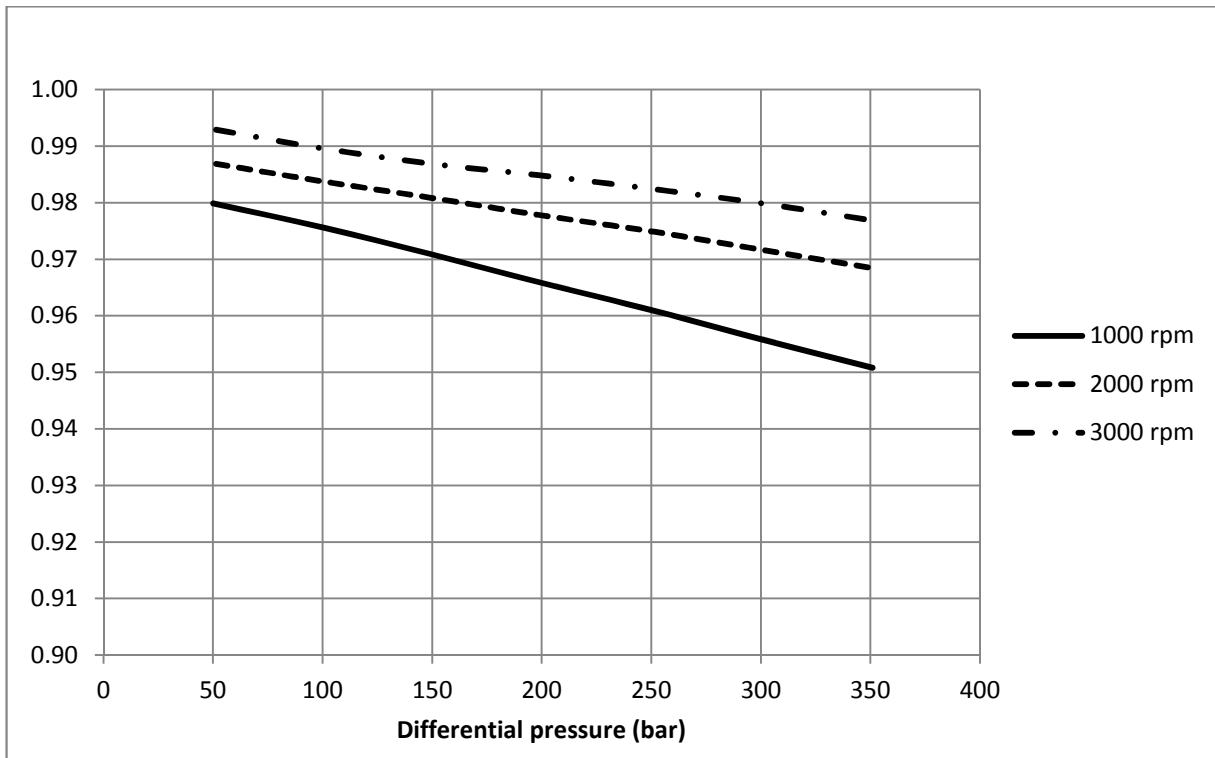

SCM 034 Hydraulic-mechanical efficiency

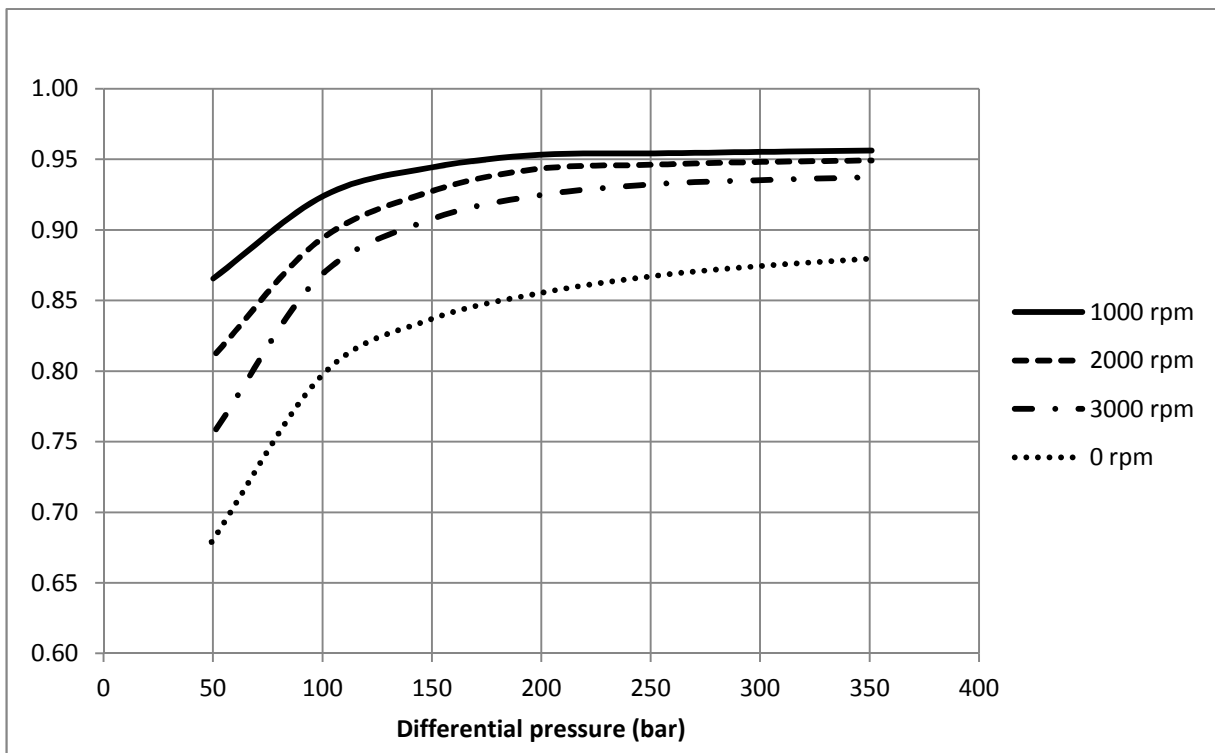

SCM 040 Volumetric efficiency

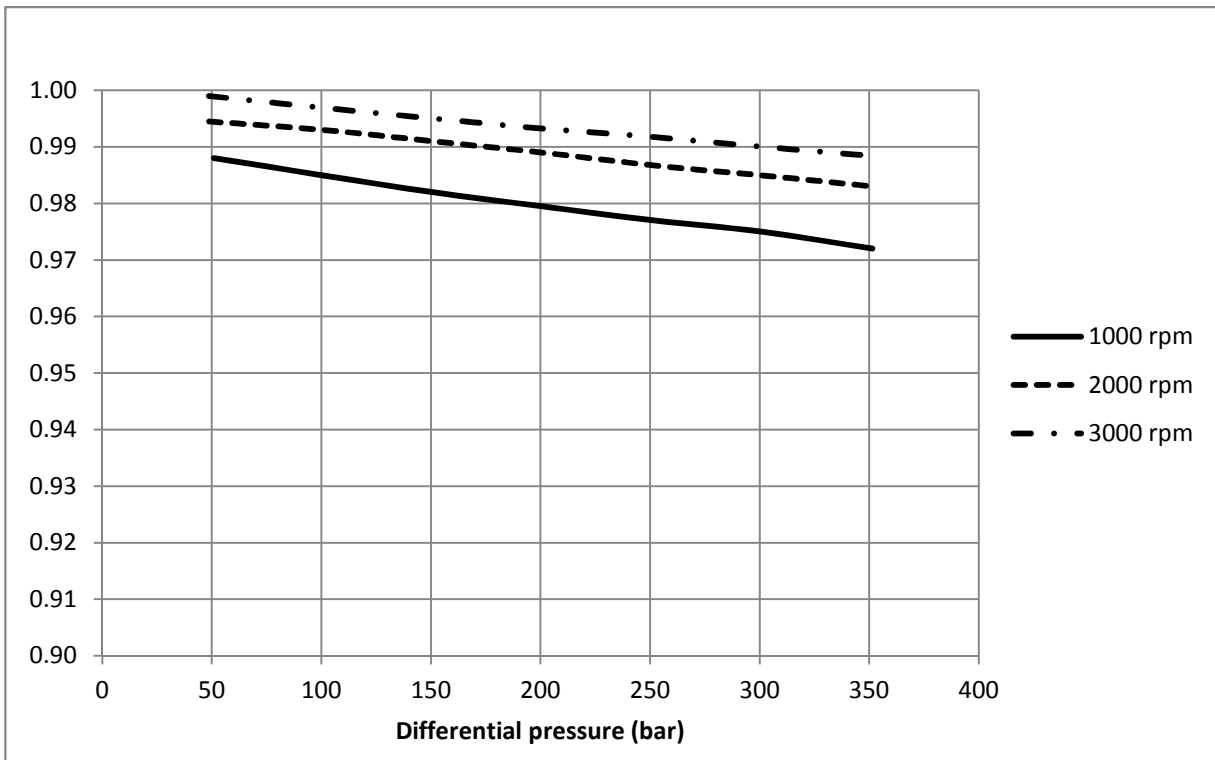

SCM 040 Hydraulic-mechanical efficiency

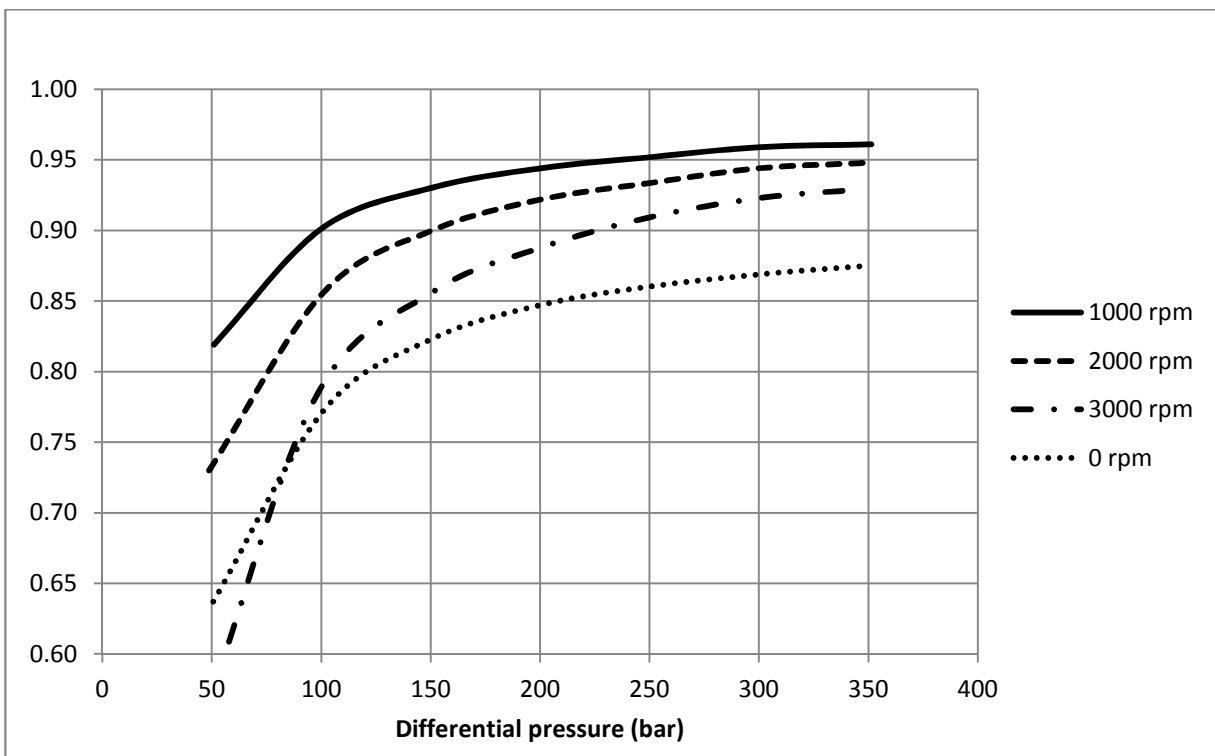

SCM 047 Volumetric efficiency

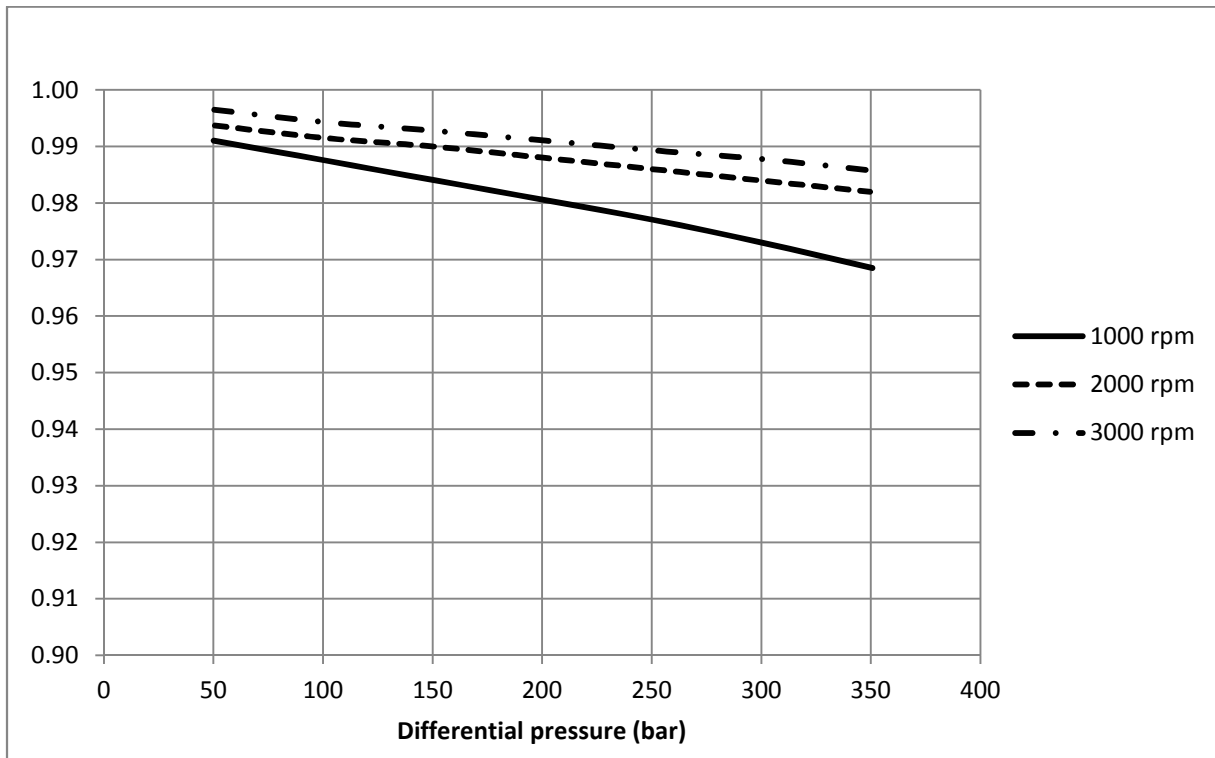

SCM 047 Hydraulic-mechanical efficiency

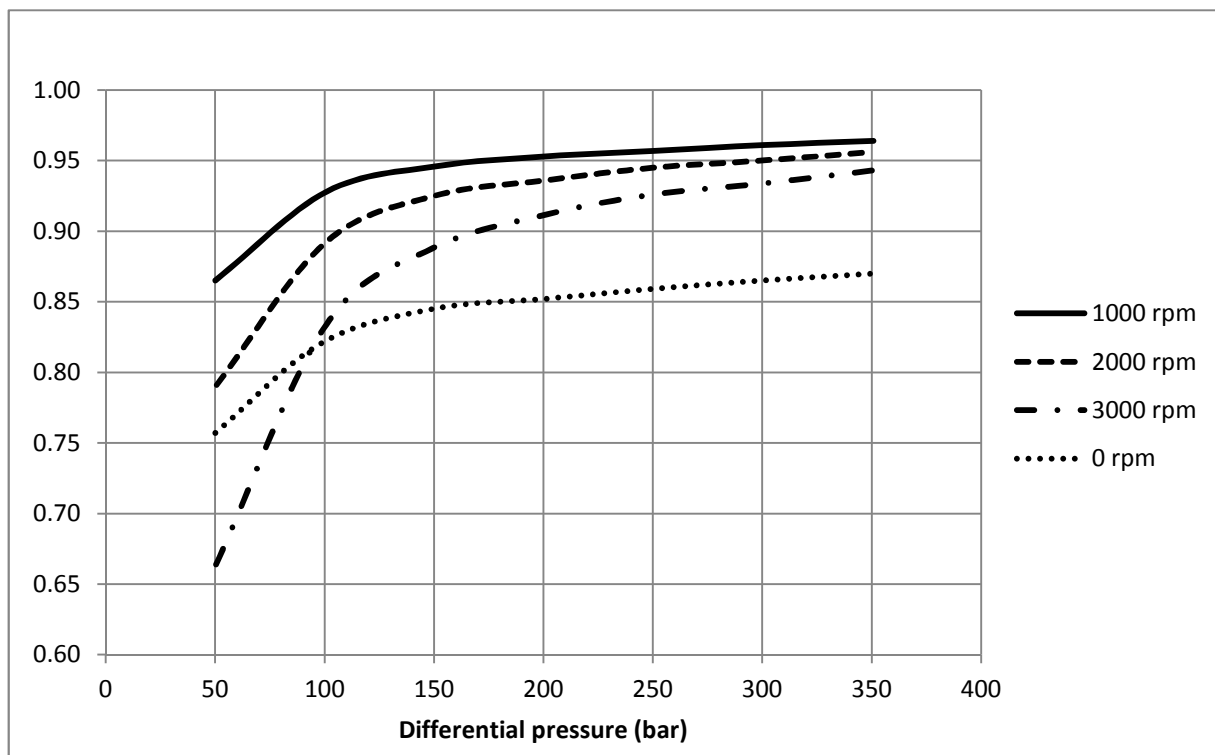

SCM 056 Volumetric efficiency

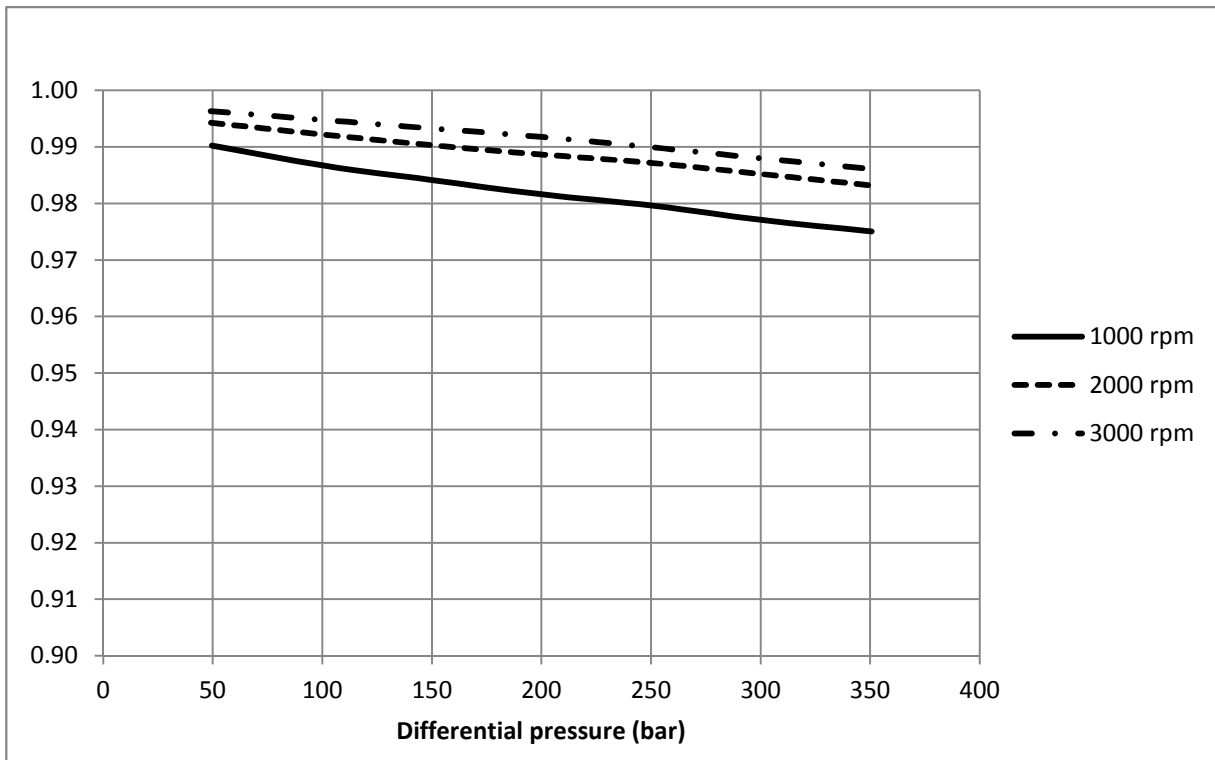

SCM 056 Hydraulic-mechanical efficiency

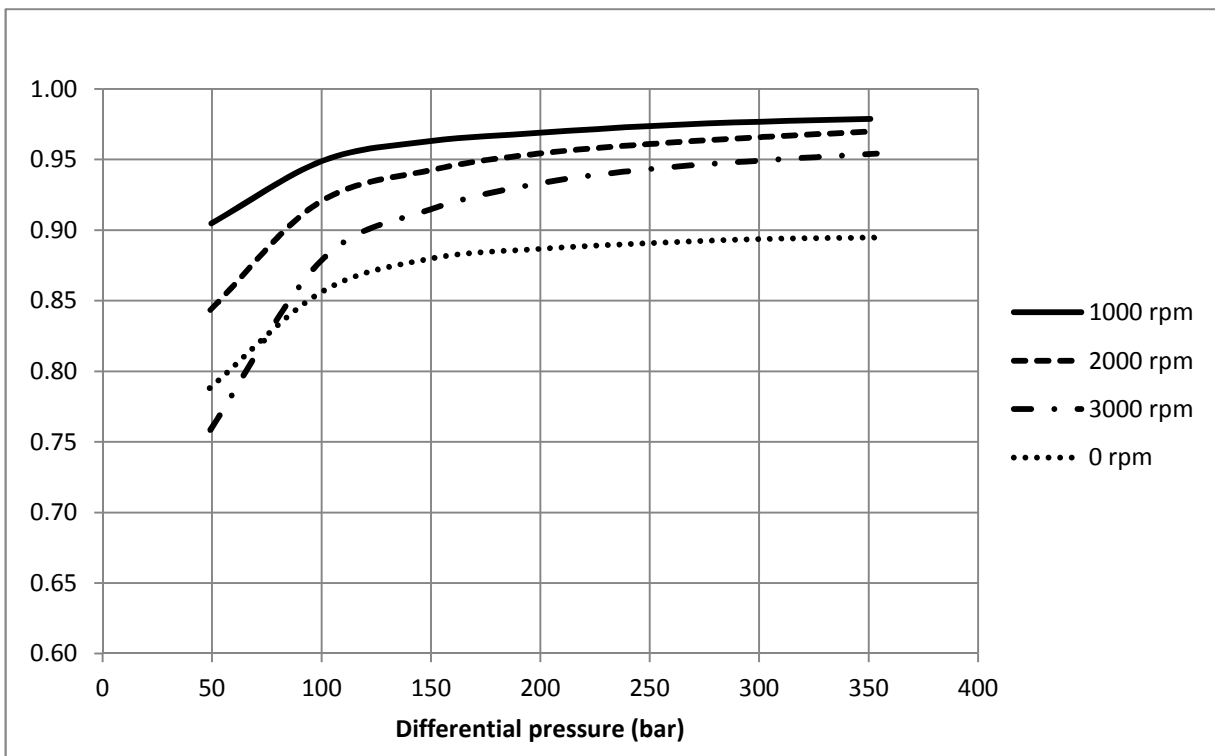

SCM 064 Volumetric efficiency

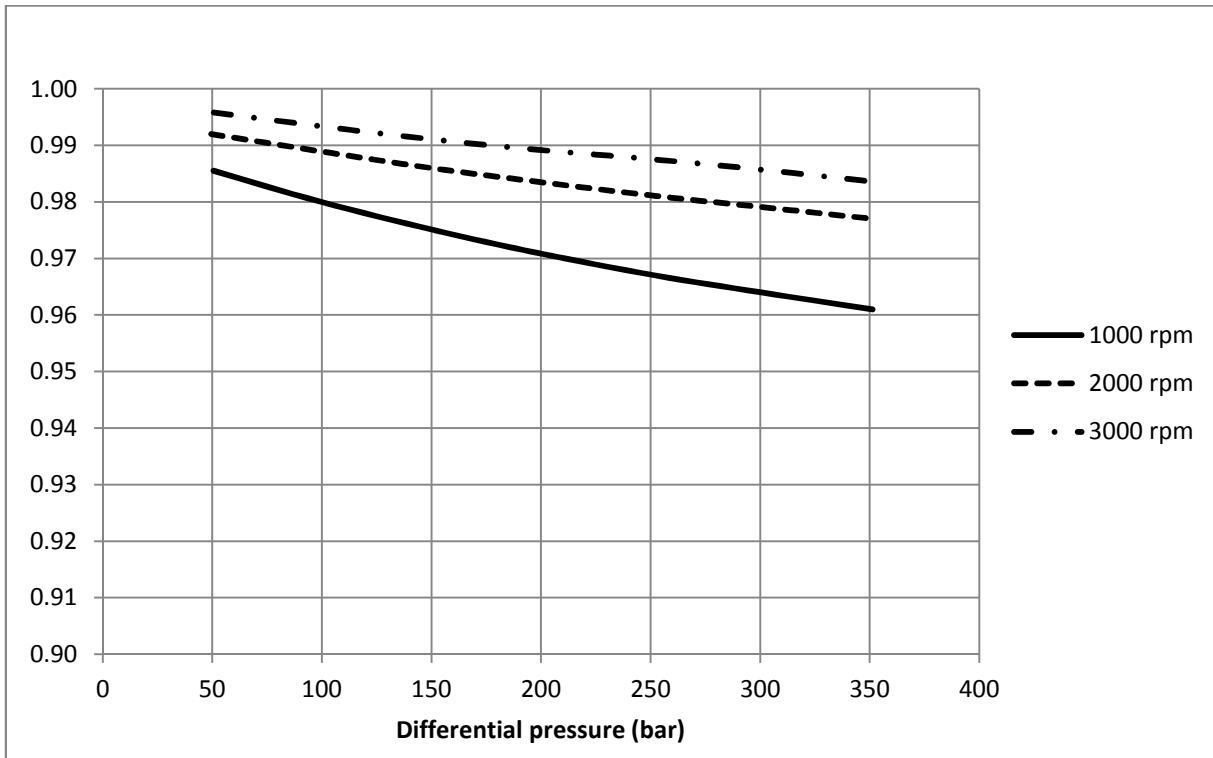

SCM 064 Hydraulic-mechanical efficiency

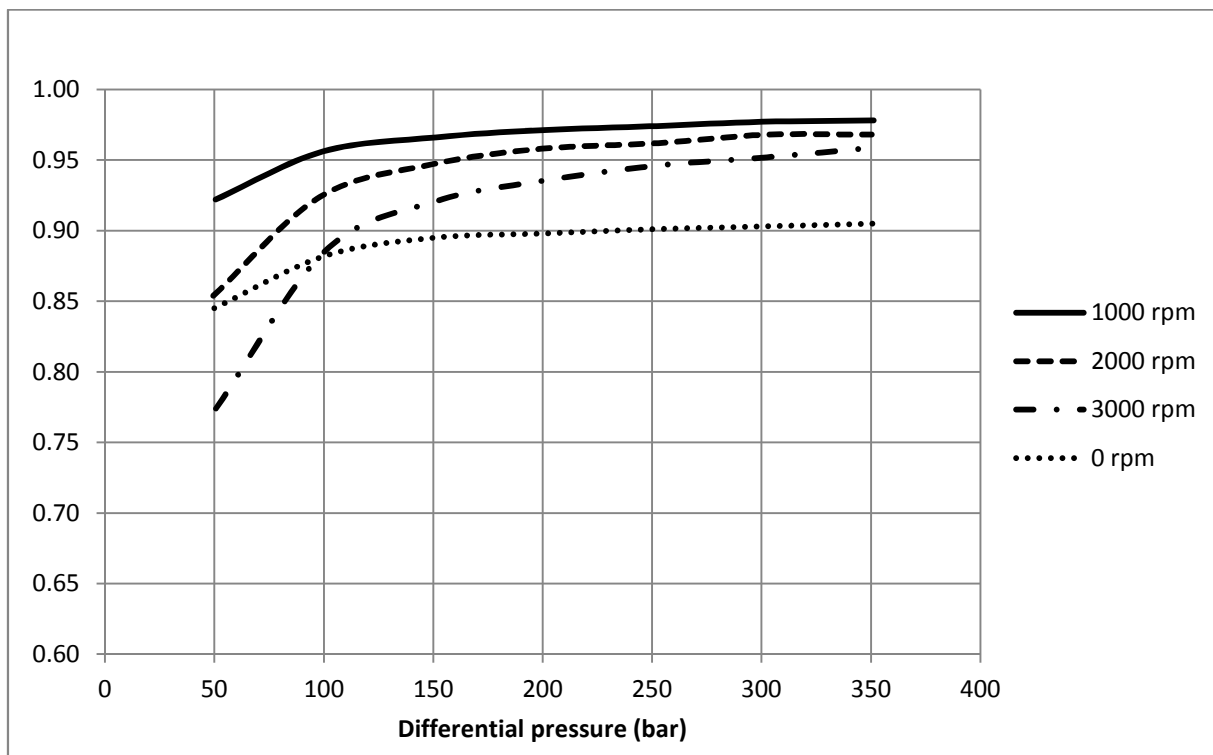

SCM 084 Volumetric efficiency

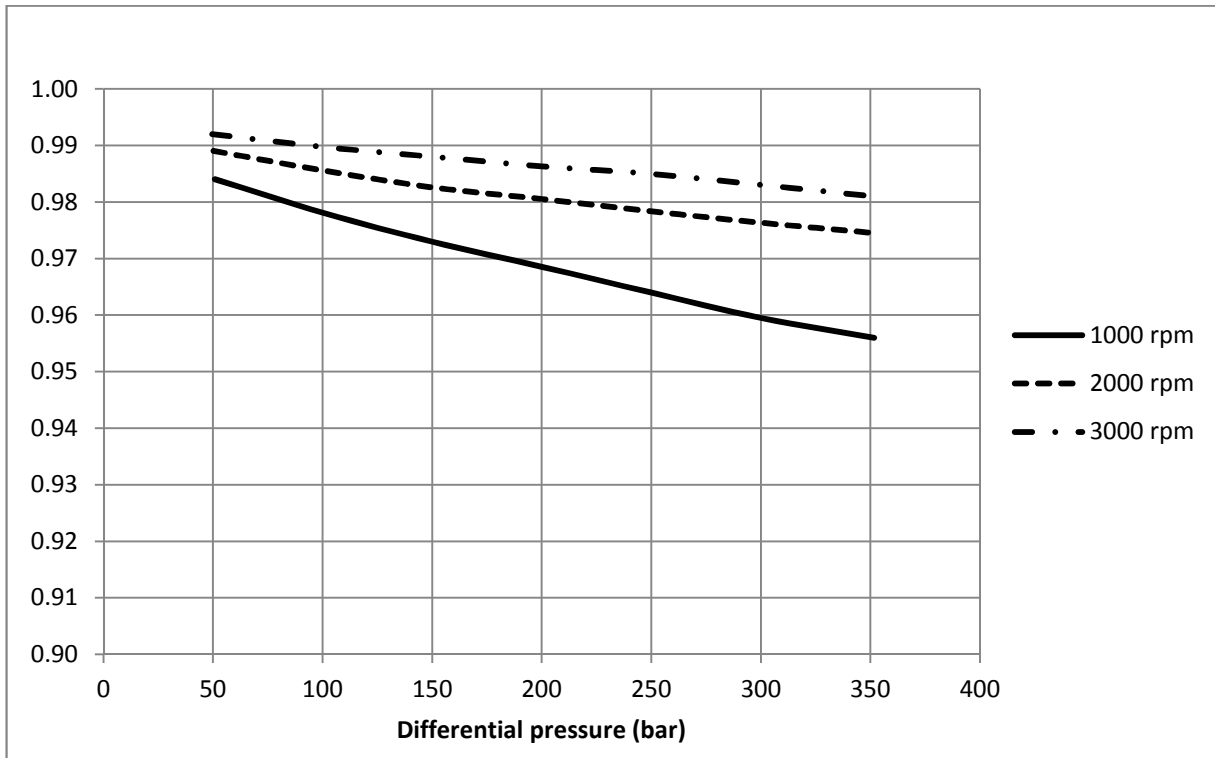

SCM 084 Hydraulic-mechanical efficiency

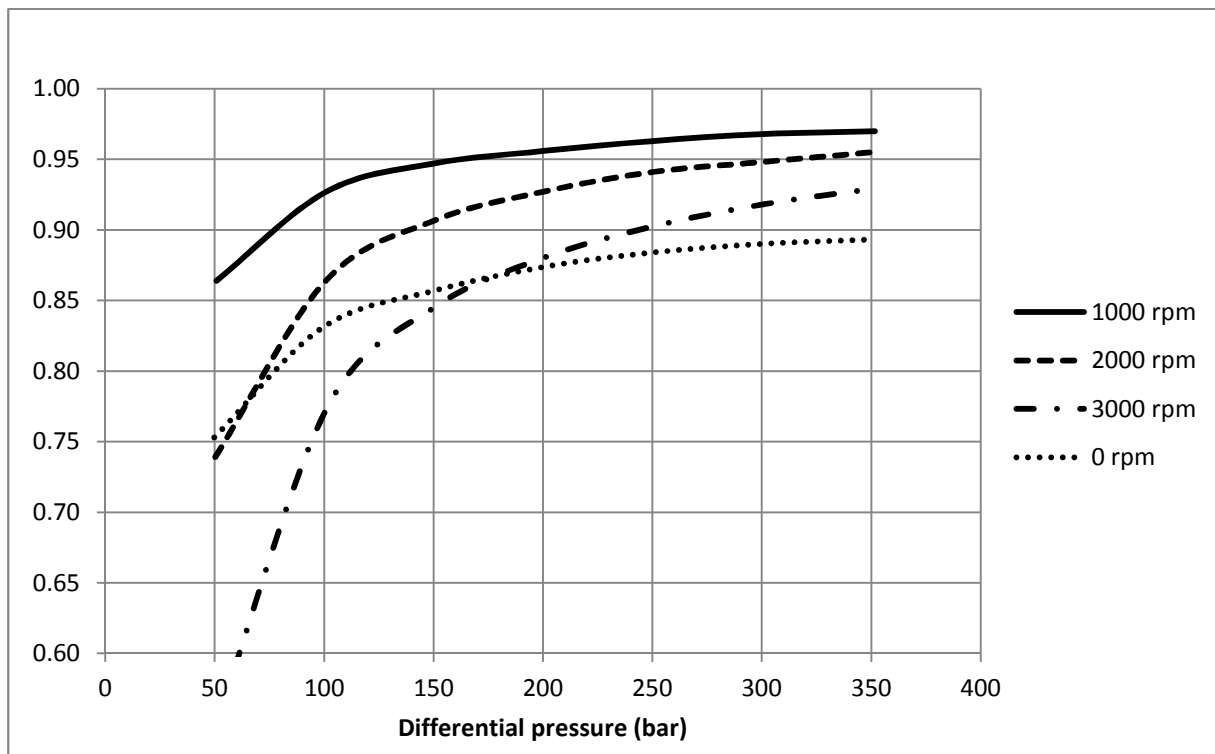

SCM 090 Volumetric efficiency

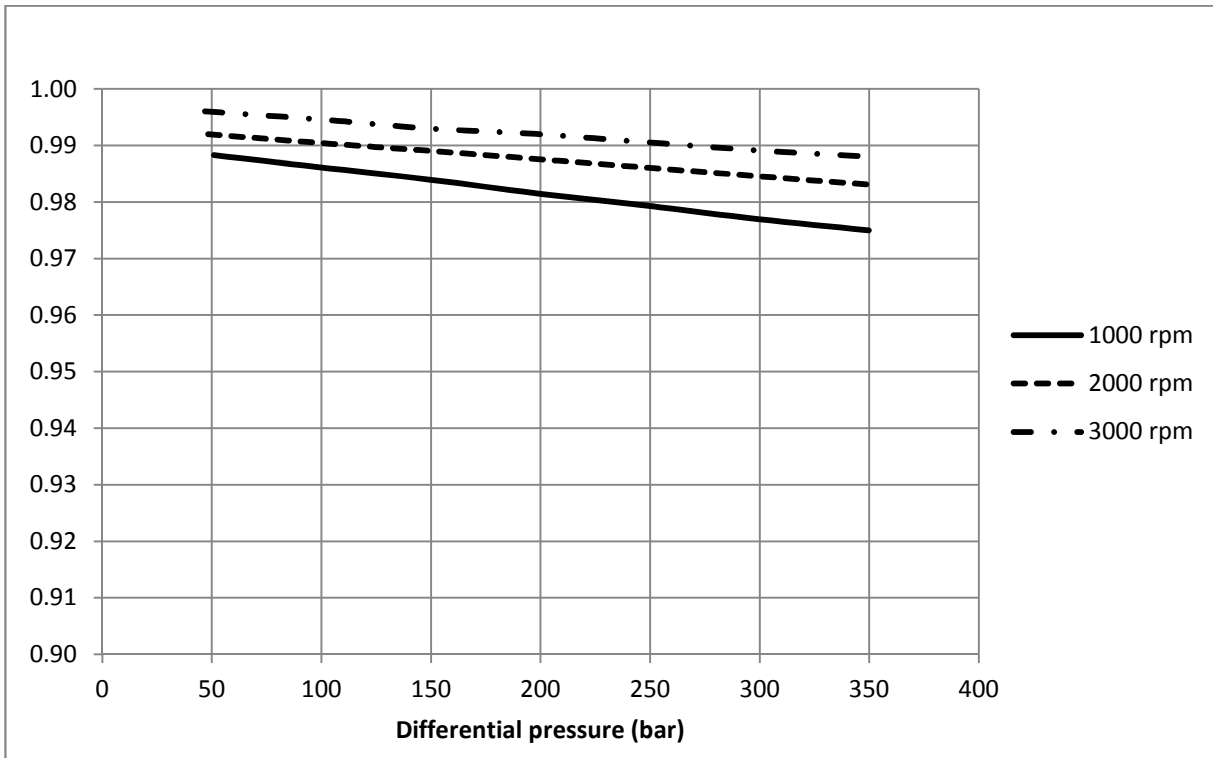

SCM 090 Hydraulic-mechanical efficiency

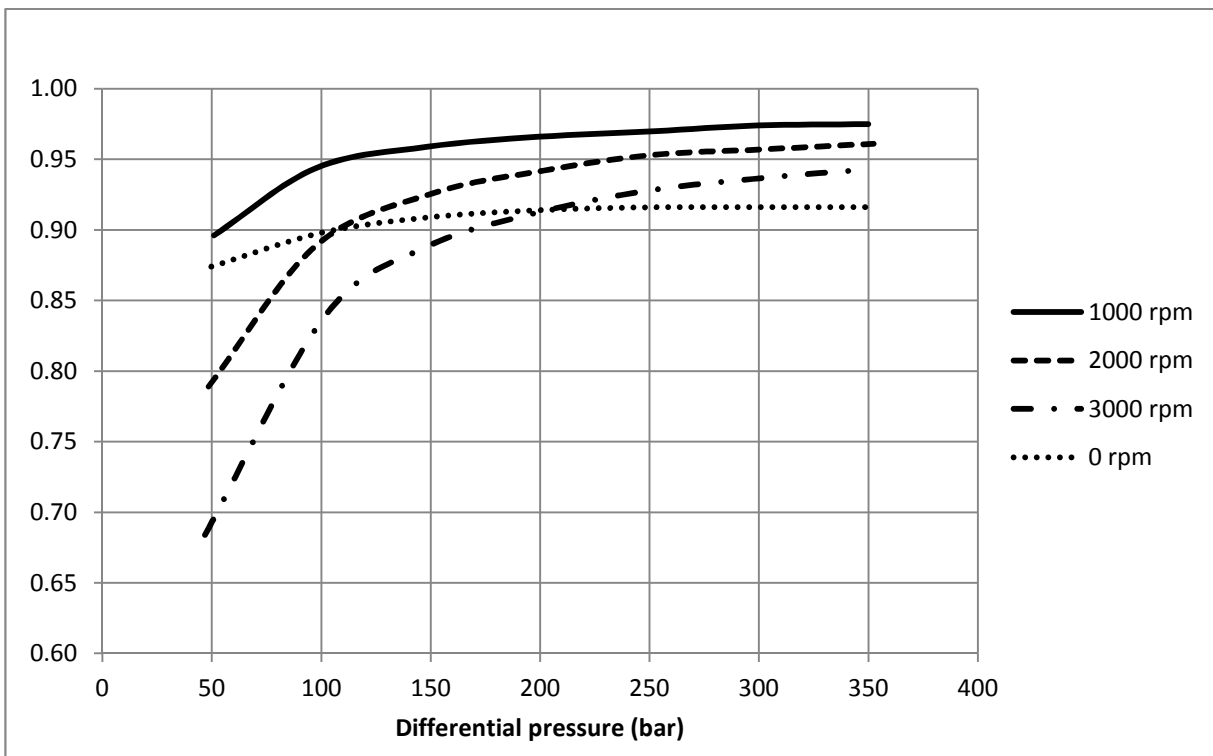

SCM 108 Volumetric efficiency

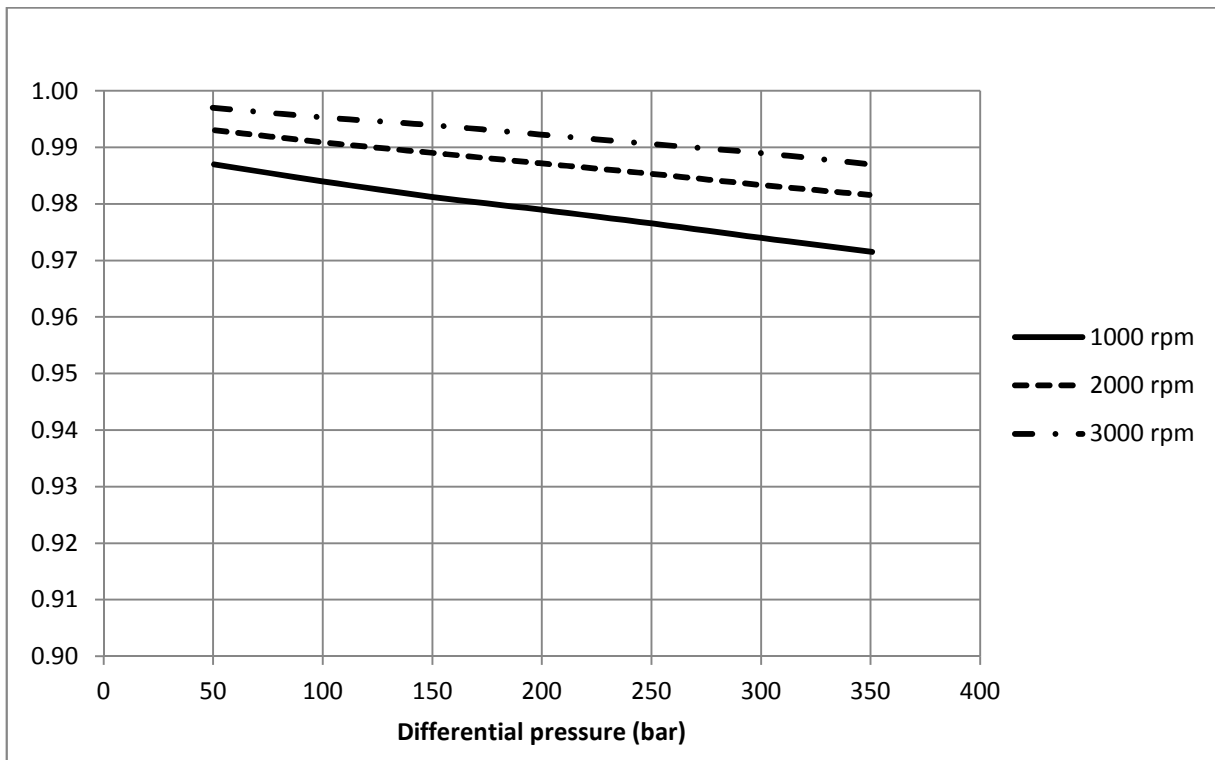

SCM 108 Hydraulic-mechanical efficiency

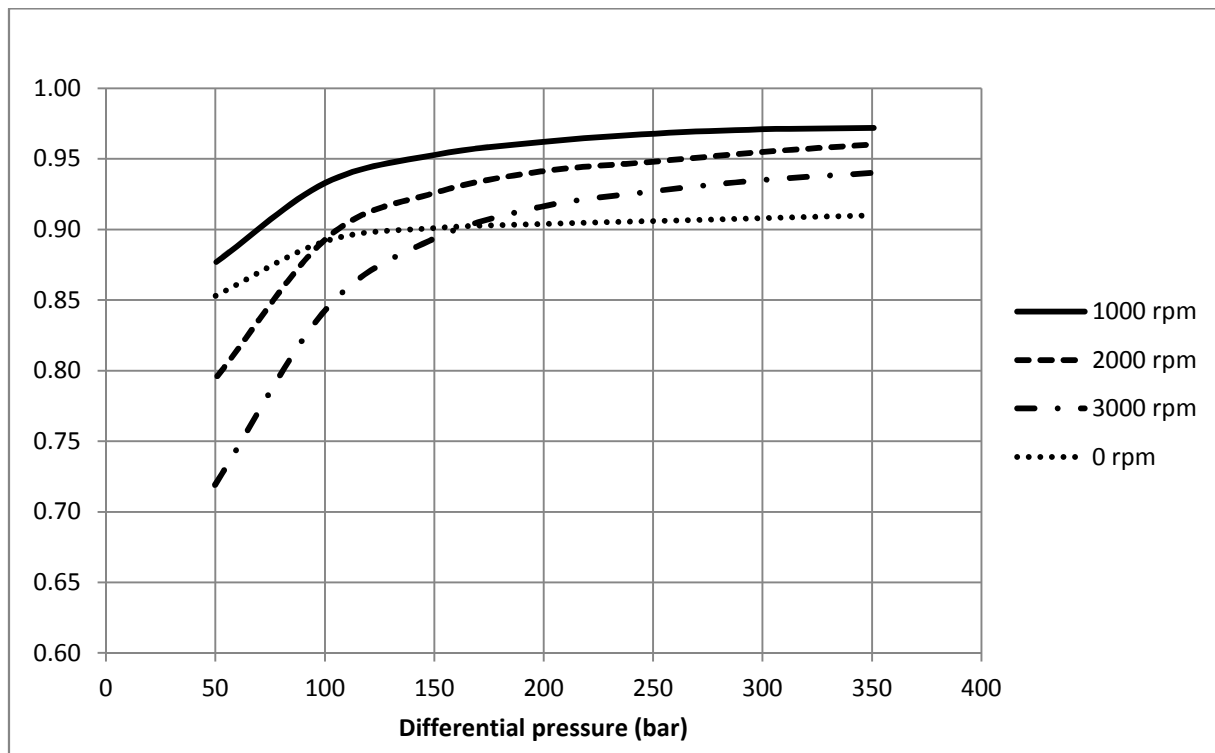

SCM 130 Volumetric efficiency

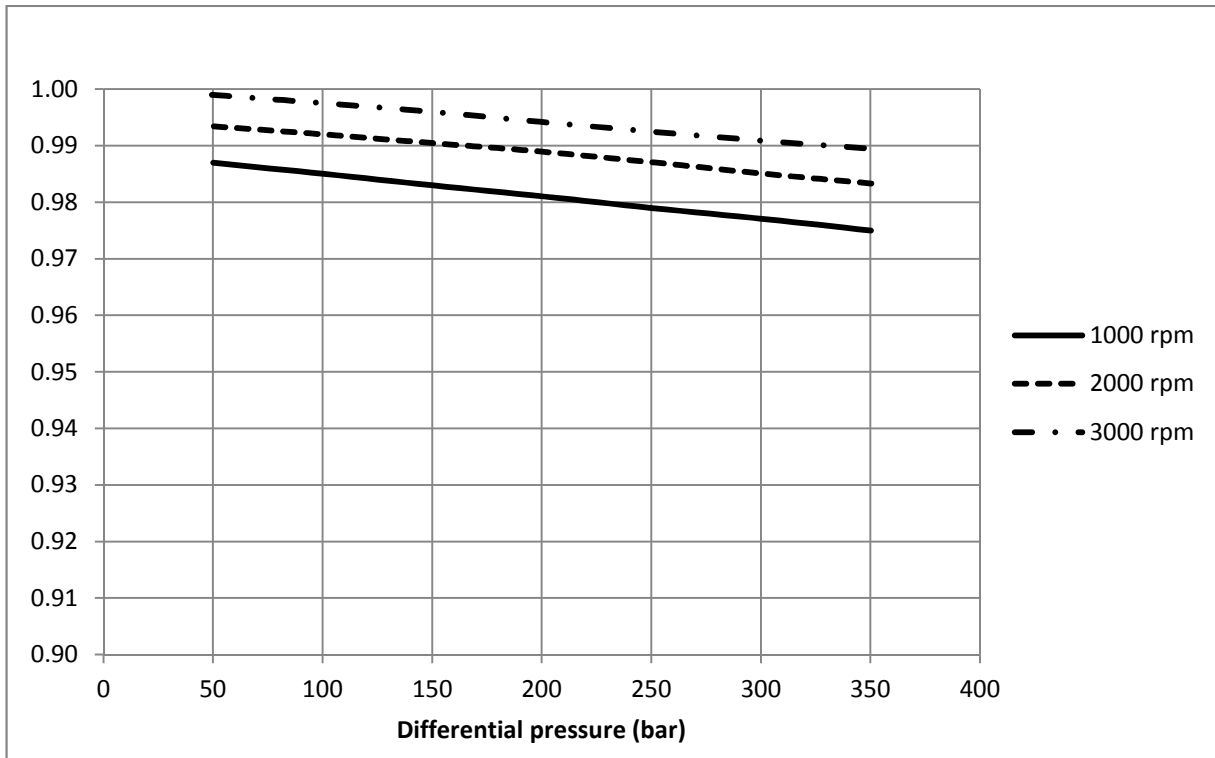

SCM 130 Hydraulic-mechanical efficiency

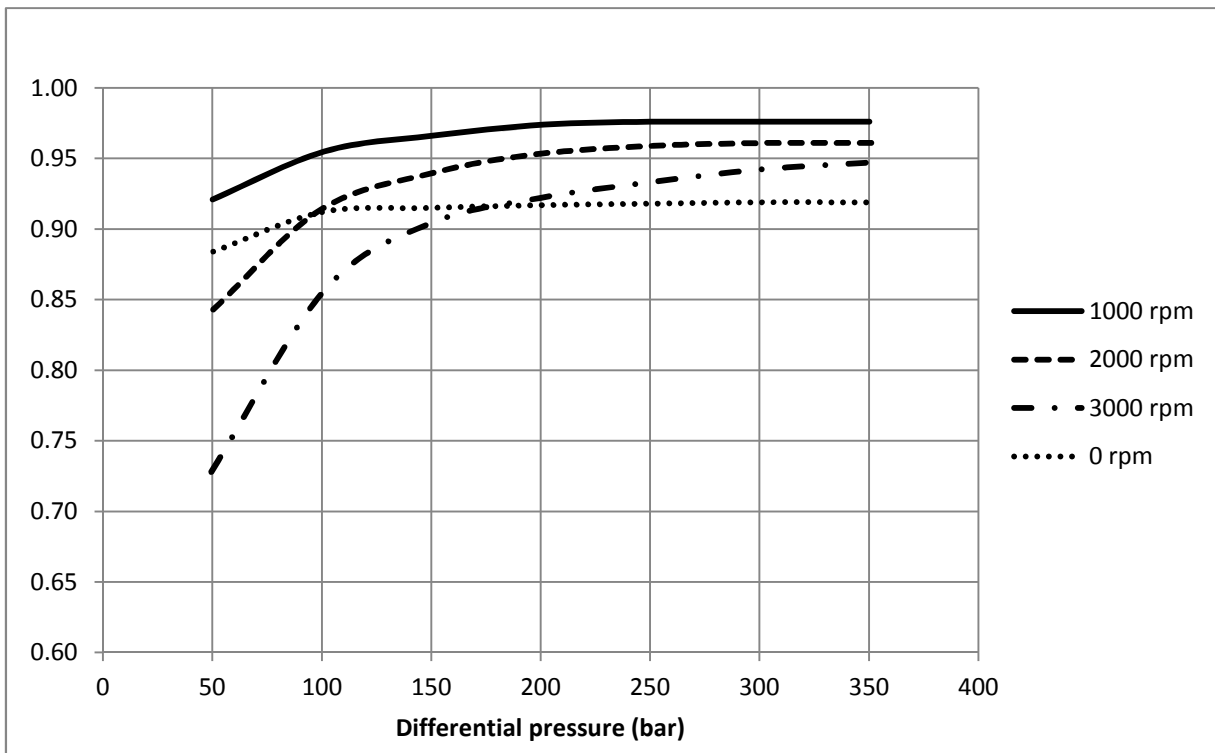

Sunfab reserves the right to make changes in design and dimensions without notice. Printing and typesetting errors reserved.
 © Copyright 2015 Sunfab Hydraulics AB. All Rights Reserved.